

begane grond

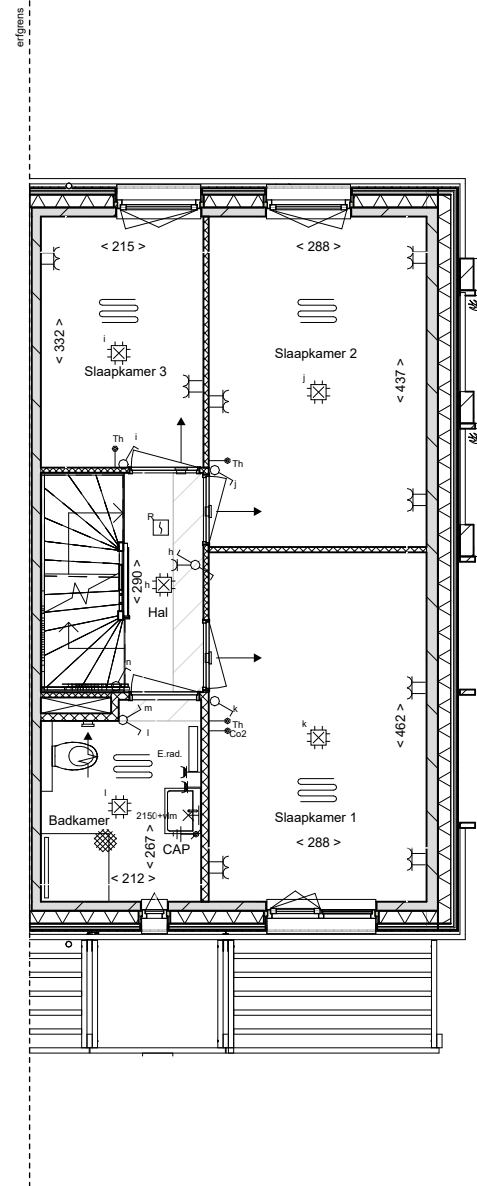

eerste verdieping

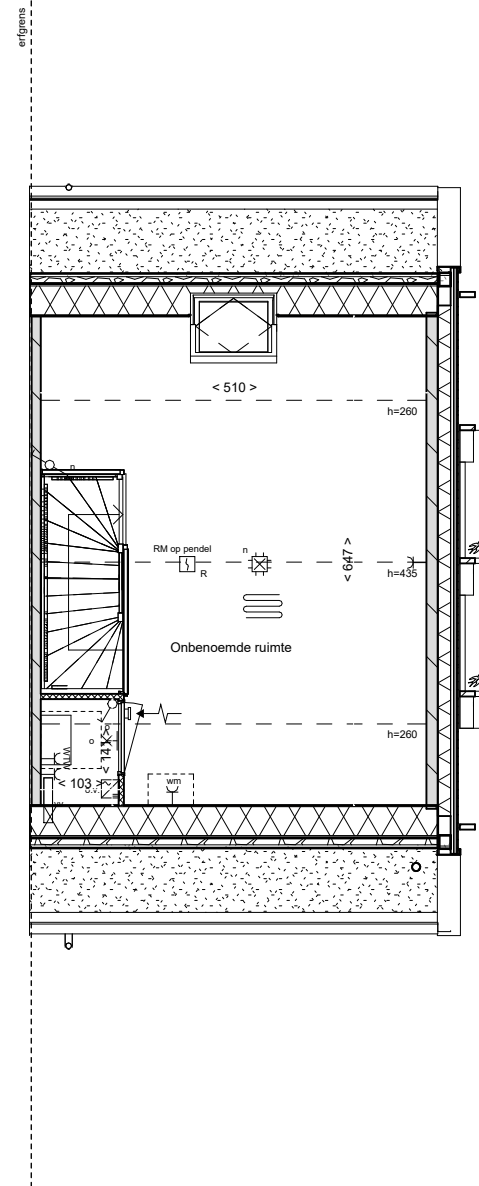

zolder

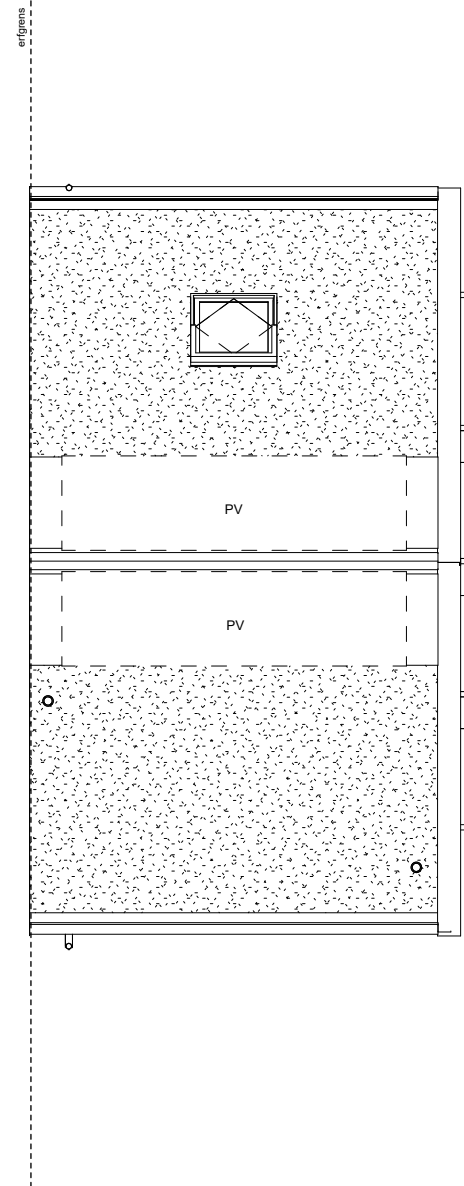

dakaanzicht

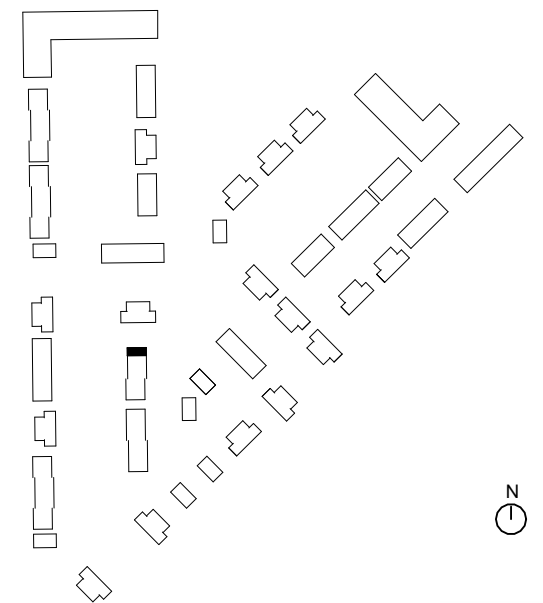

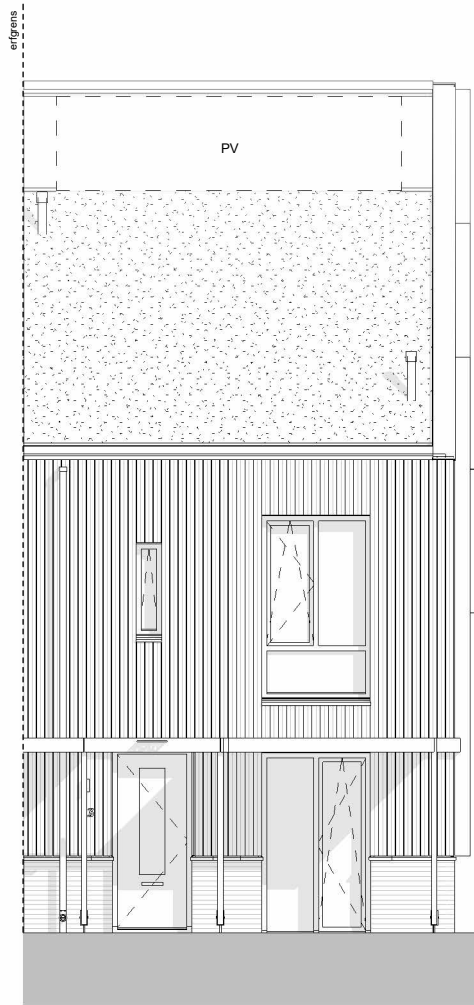

voorgevel

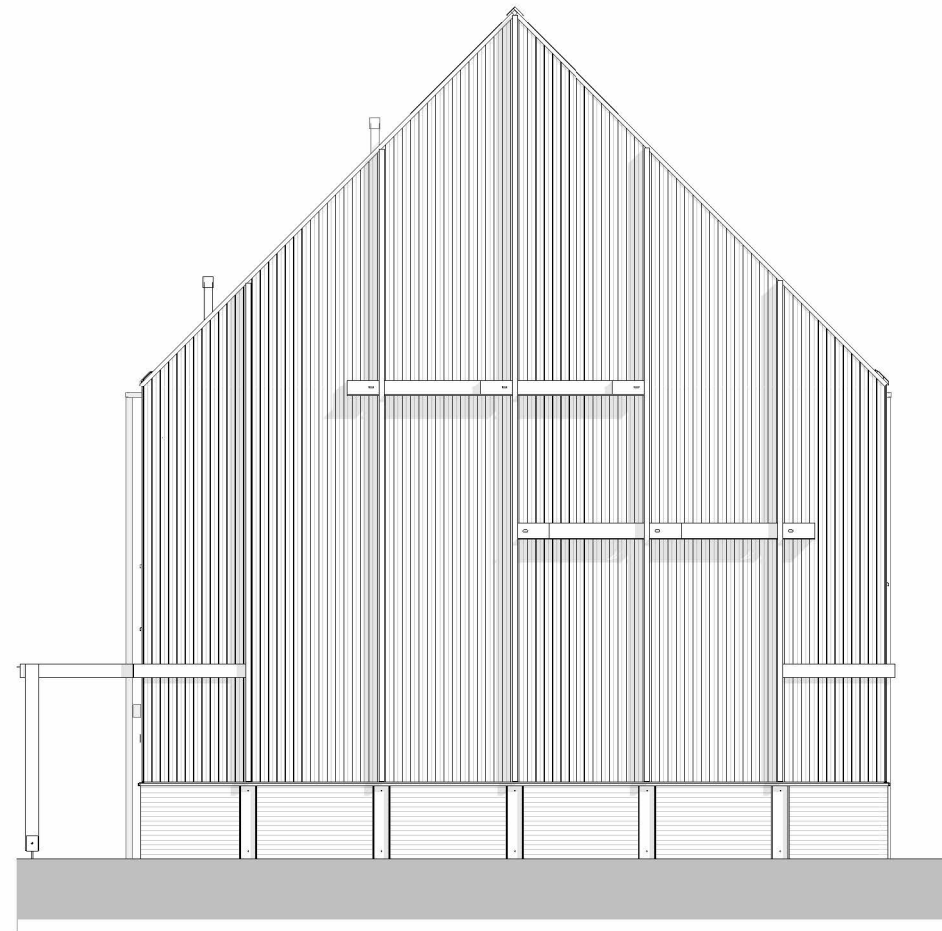

kopgevel gierzwaluw kasten

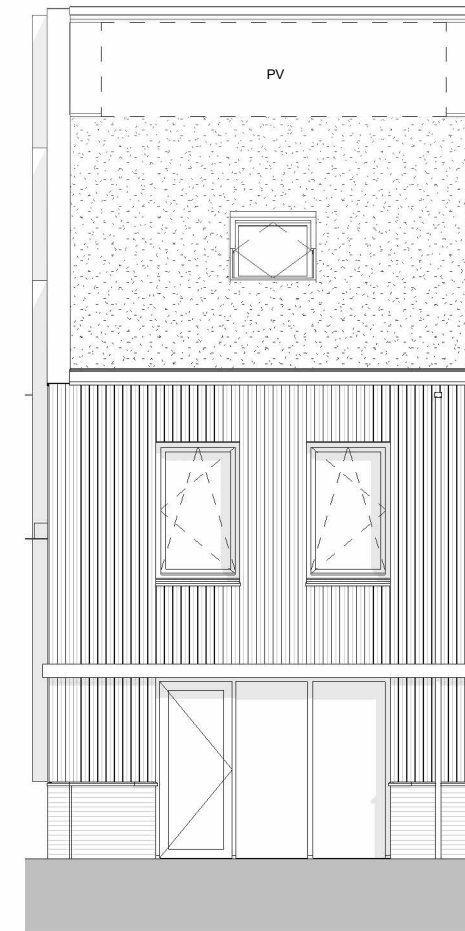

achtergevel

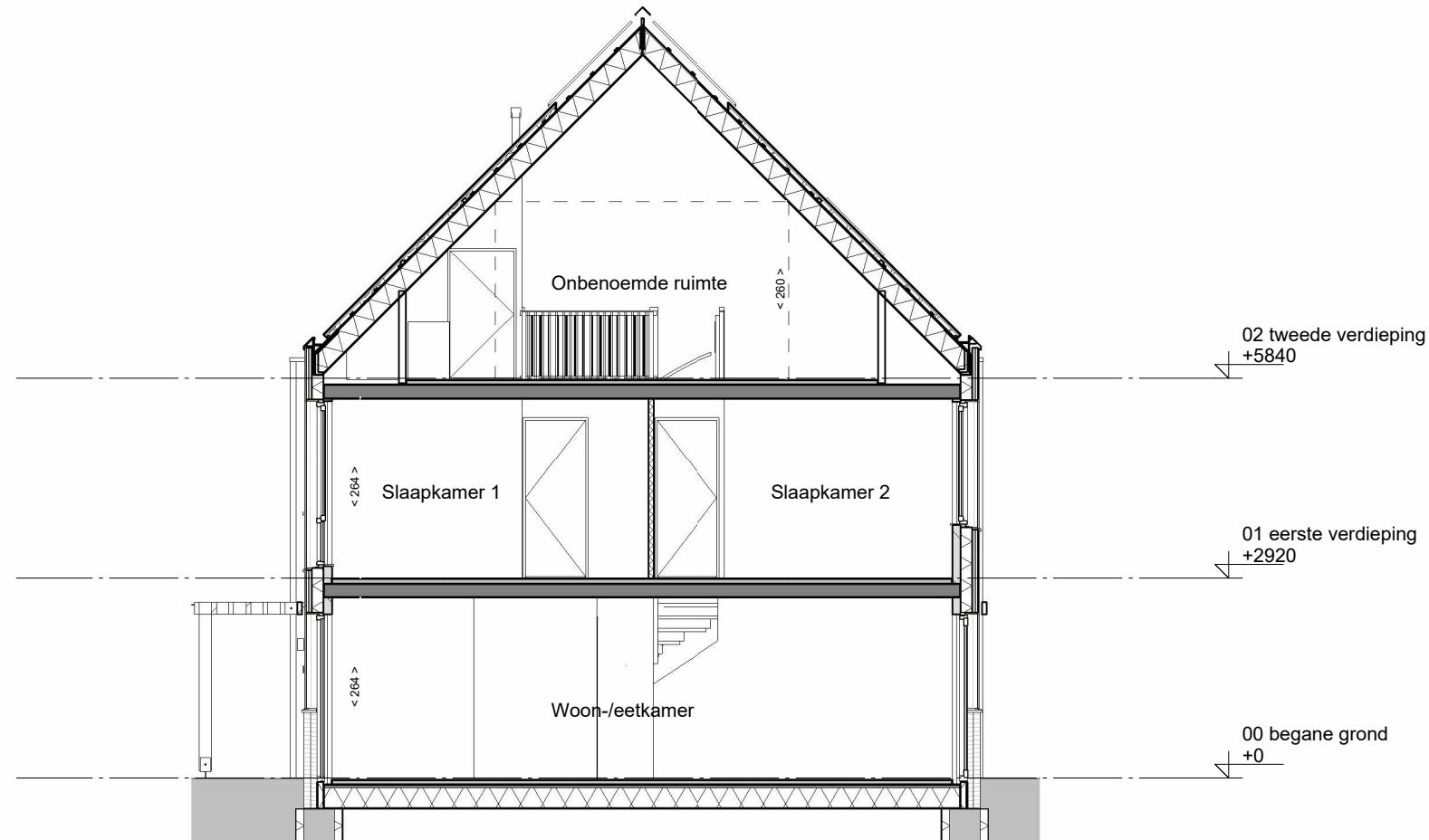

doorsnede

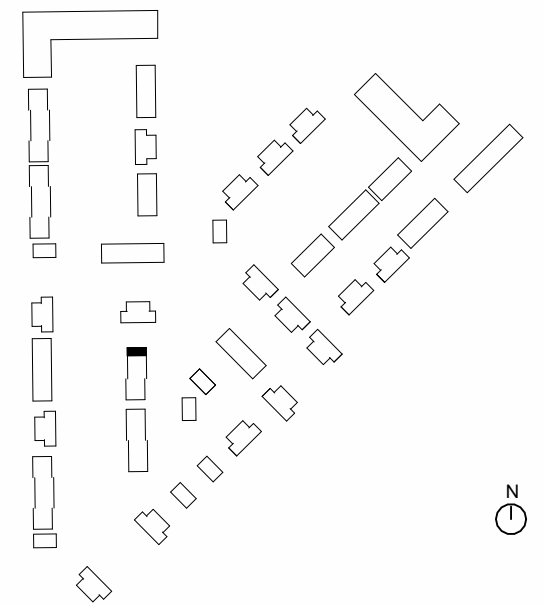

Omschrijving
Gevelaanzichten en doorsneden

Onderdeel Verkooptekening	70	tekeningnummer VK-070-2	getekend 24-09-2024	schaal 1 : 100	formaat A3
------------------------------	----	----------------------------	------------------------	-------------------	---------------

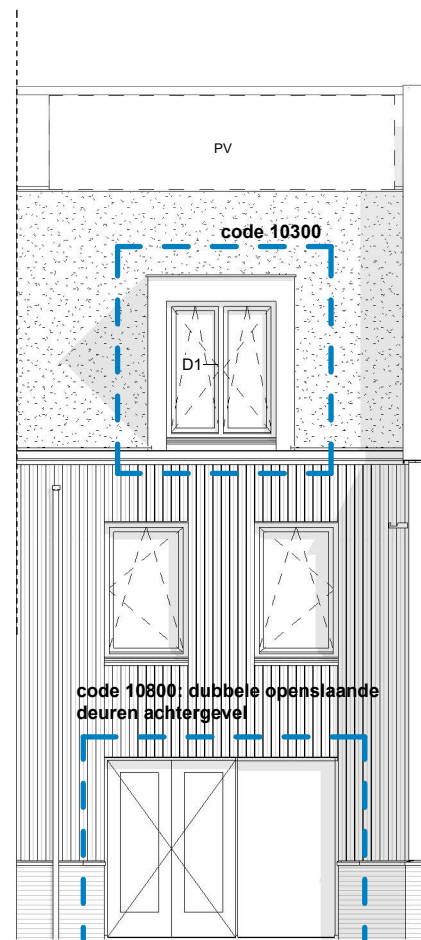

achtergevel

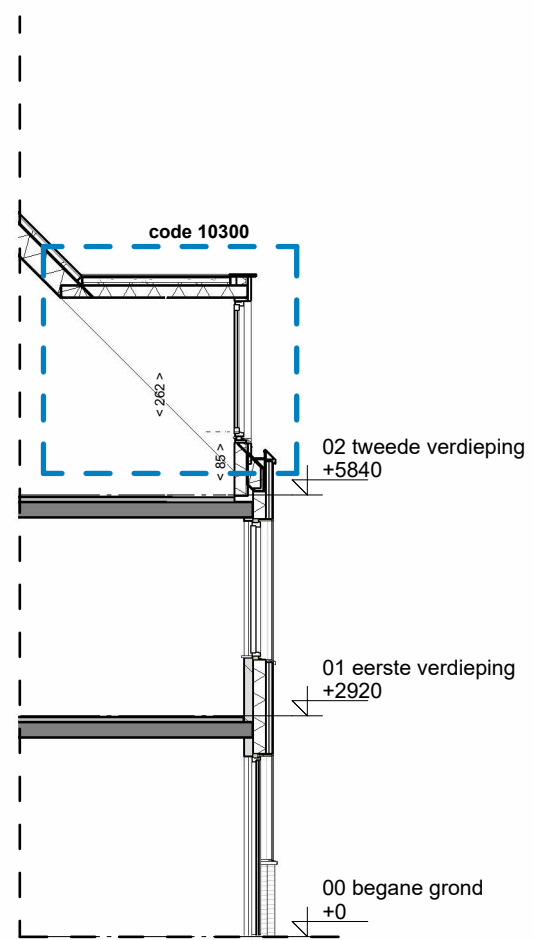

doorsnede

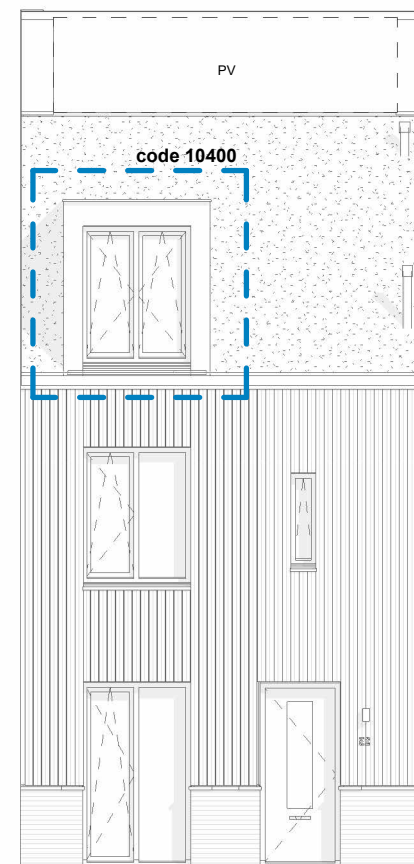

voorgevel

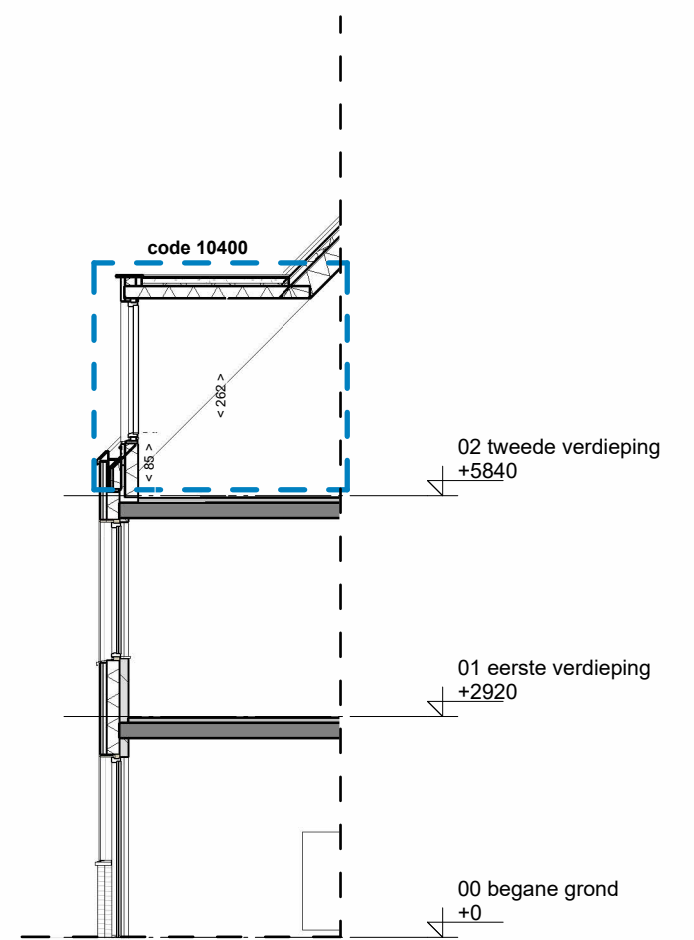

doorsnede

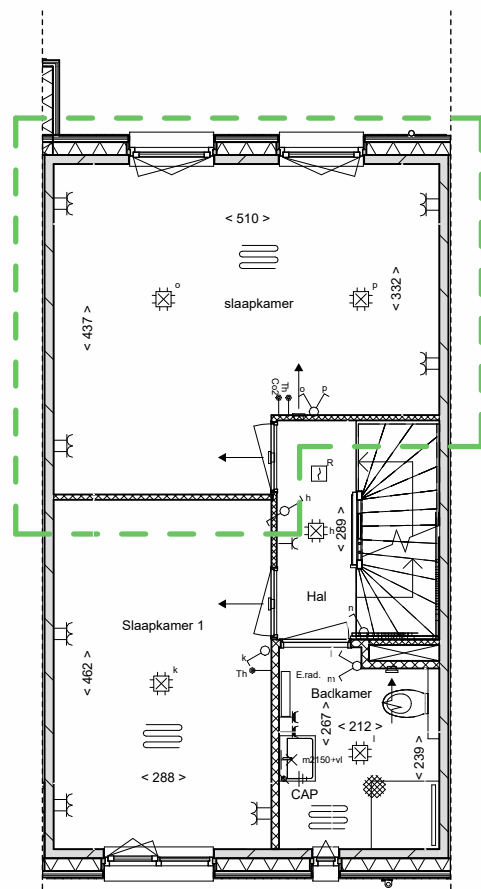

eerste verdieping

code 12100: slaapkamers samenvoegen

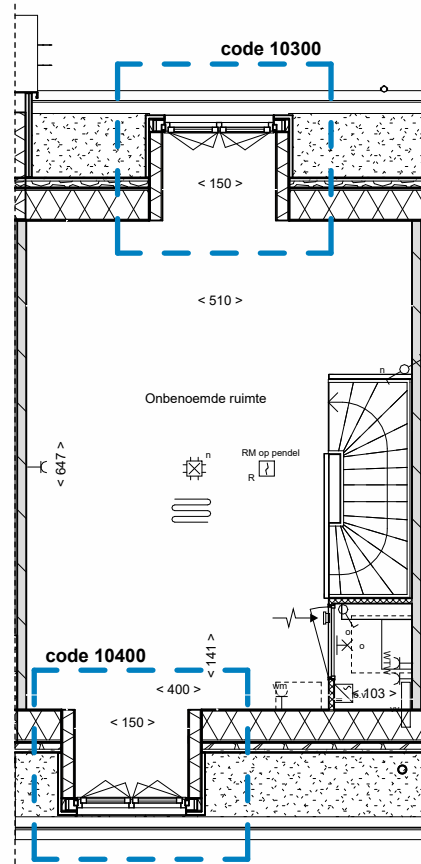

tweede verdieping

code 10300: dakkapel achtergevel
code 10400: dakkapel voorgevel

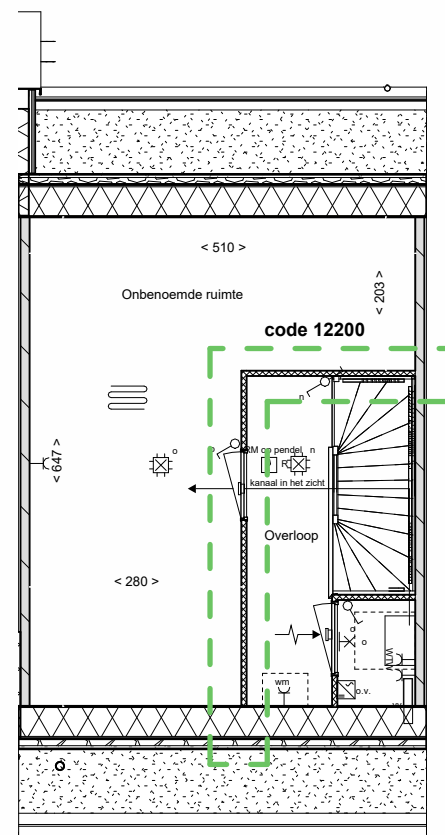

tweede verdieping

code 12200: zolderindeling

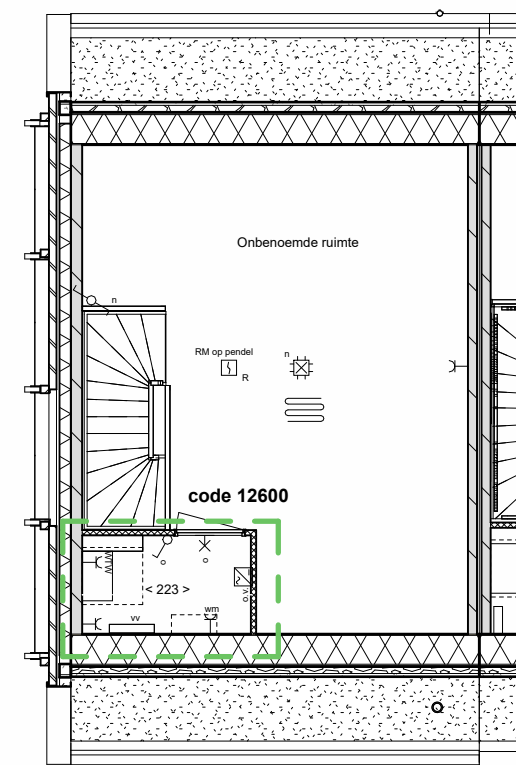

tweede verdieping

code 12600: grote technische ruimte

NB:
Kopersopties slechts ter indicatie van de extra ruimte en bijbehorende gevelopeningen; materialisatie van de gevel (hout of metselwerk, veranda of luifel) wijkt mogelijk af van uw bouwnummer.

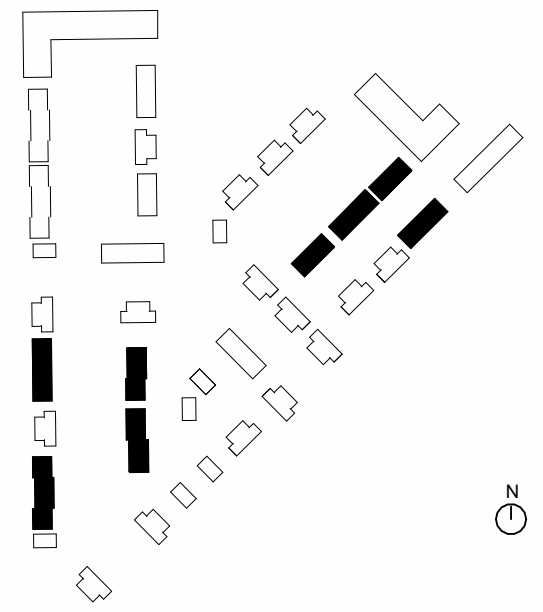

Omschrijving
Kopersopties

Onderdeel	tekeningnummer		
Verkooptekening	VK-020-3		
Bouwnummer(s)	getekend	schaal	formaat
19 t/m 33, 70 t/m 80	24-09-2024	1 : 100	A3

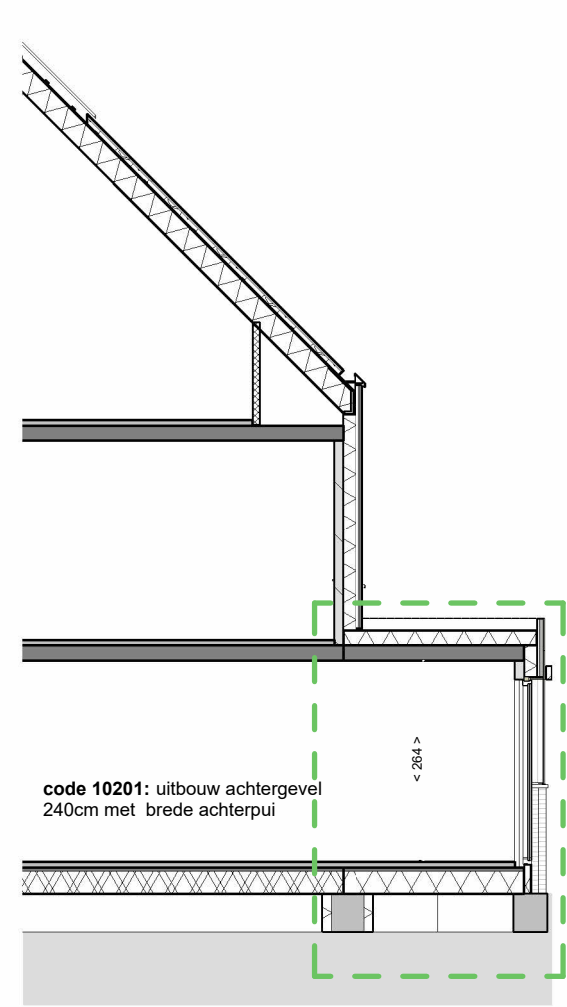
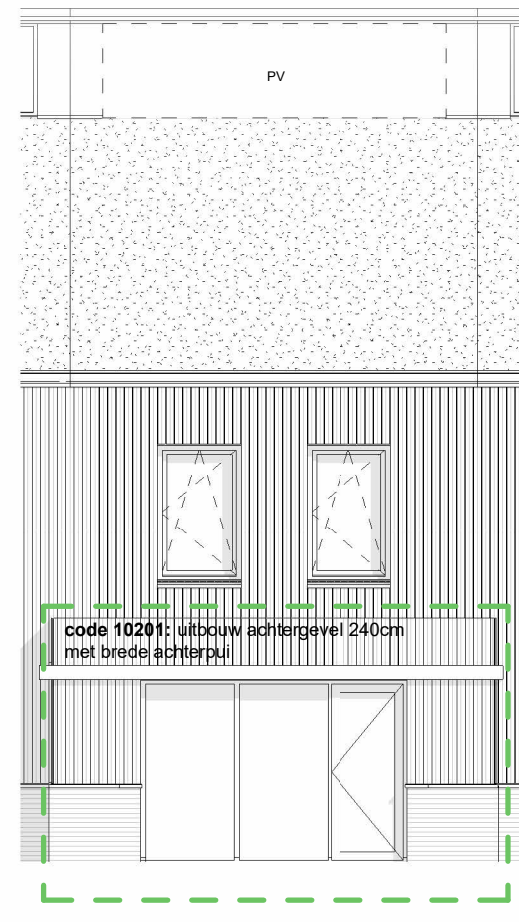
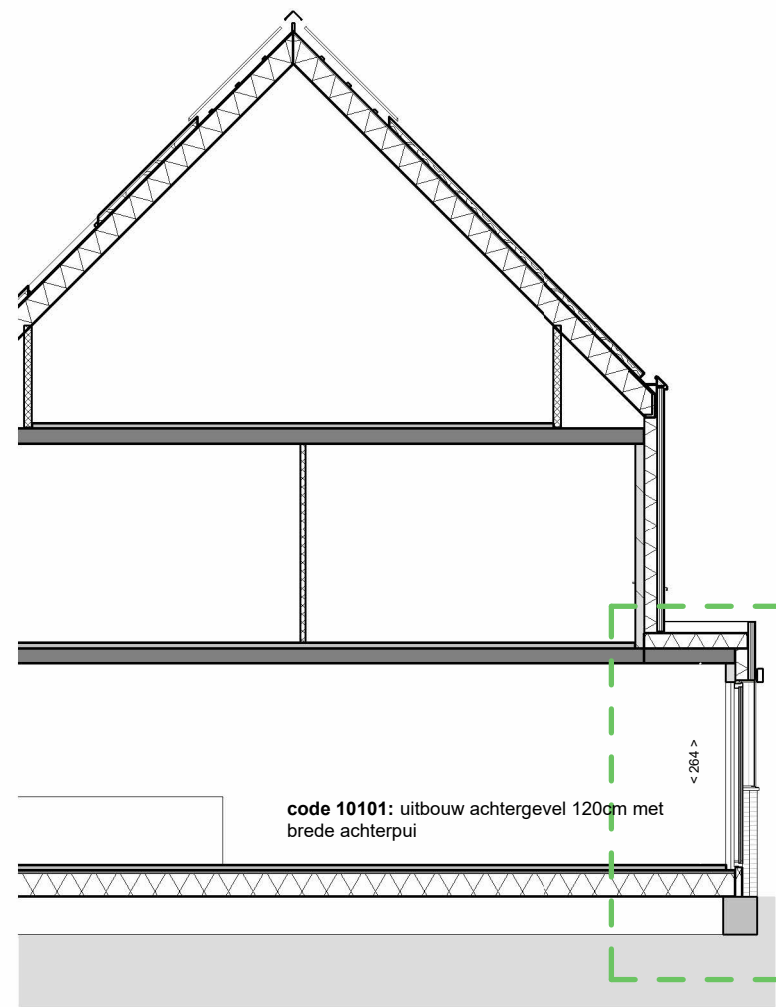
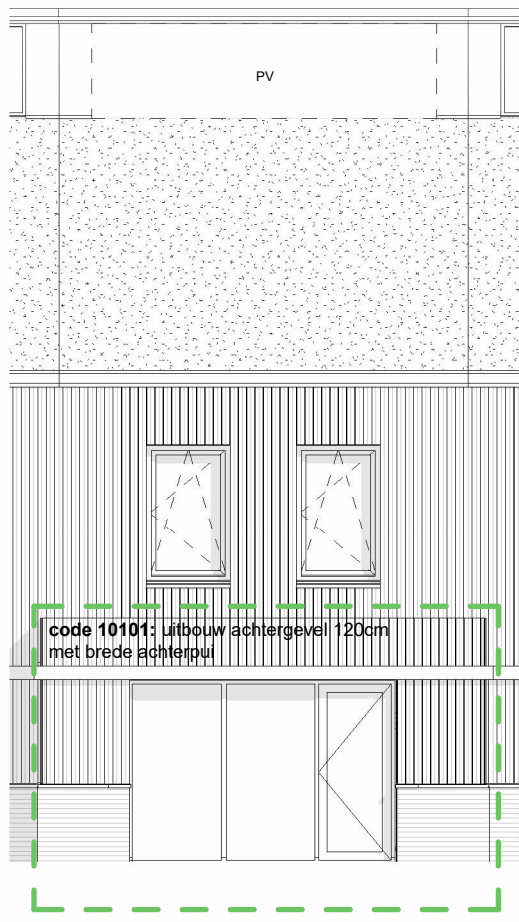

achtergevel

doorsnede

achtergevel

doorsnede

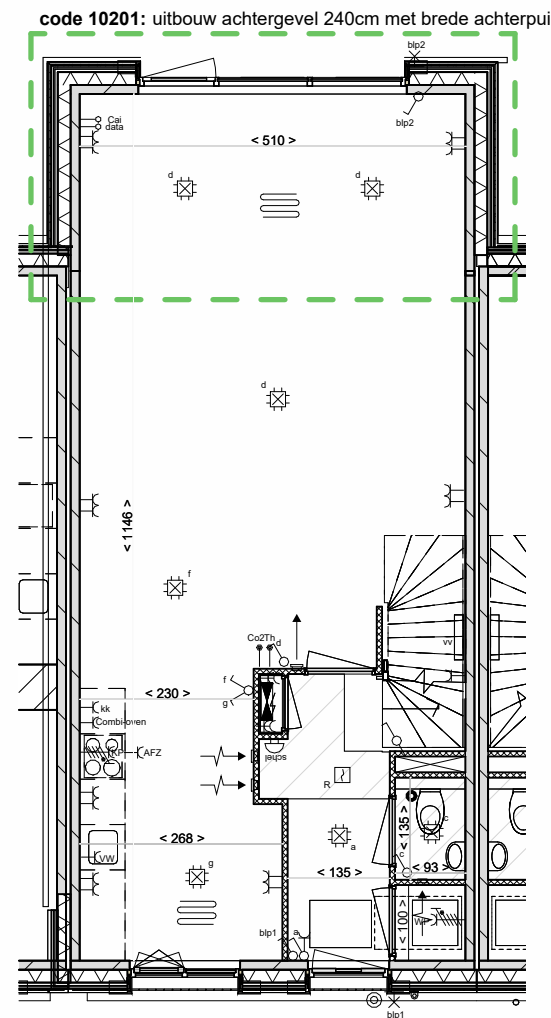
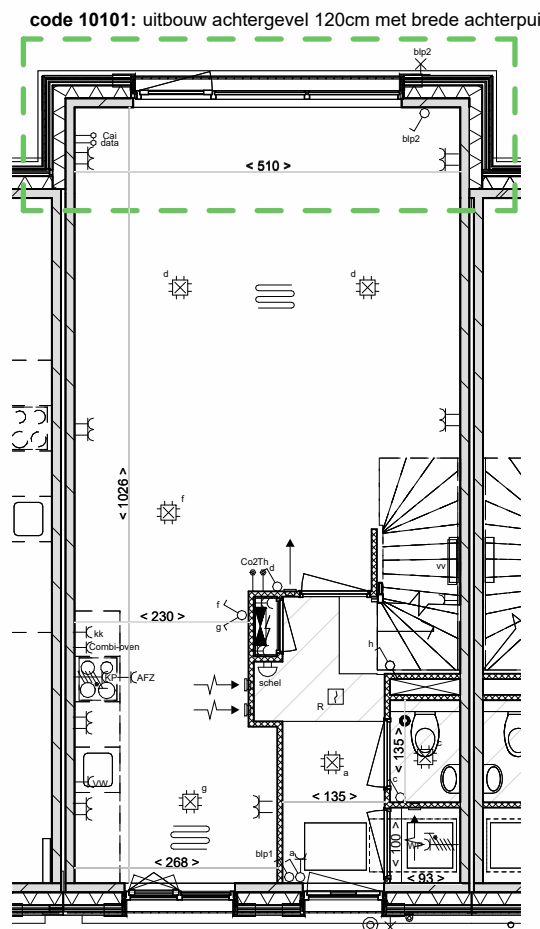

begane grond

begane grond

